



M-POWER-4T

AC POWER & DATA CONNECTIVITY SOLUTION

M-POWER-4T-AAUU-BZATP

Distributed by



Mormax Company, Inc.

8 Westchester Plaza

Elmsford, NY 10523

914-699-0101

sales@mormax.com

mormax.com

Metro Light & Power's line of power & data solutions offers sophisticated design elements combined with greater ease of installation. Streamlined and low-profile, enhanced by side-exiting cords, our outlets advance the industry with their cutting-edge look and feel. We believe flexibility is key, and we provide a variety of mounting options, including the ability to mount in limited spaces. Our outlets are available in many finishes and configurations, in addition to a custom color and finish capability for our clients.

Trim Plate Finish: **STANDARD BRONZE (ABS)**

Custom Finishes Available M-POWER-4T-AAUU-BZATP

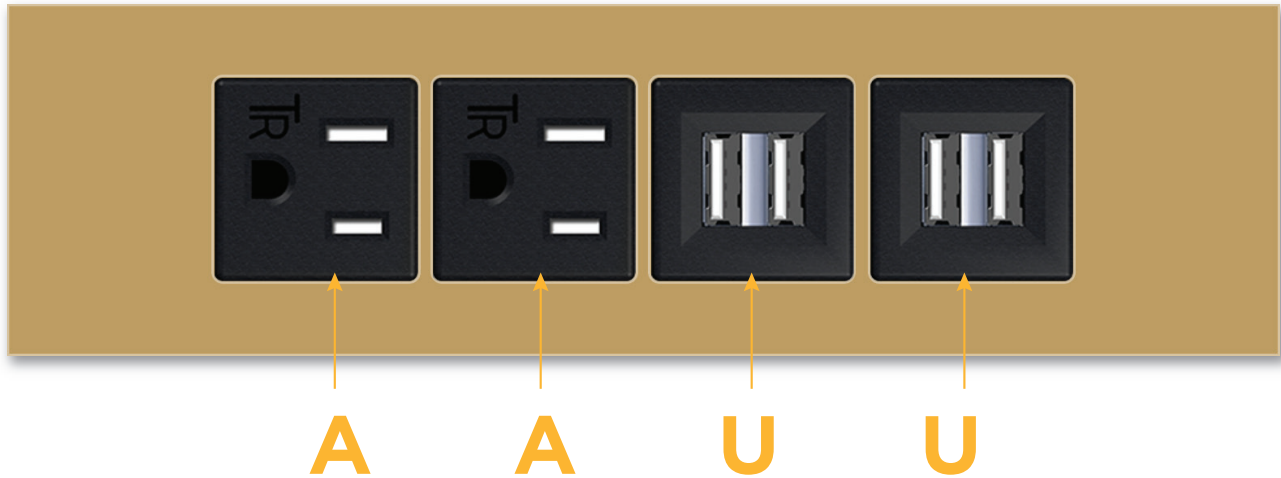

Features:

Module/Port Options:

- A** Tamper Resistant AC Receptacle
- B** USB-A & USB-C
- U** Double USB-A (Fast Charging Ports - Rated for 3.2A)
- H** HDMI
- 6** CAT 6
- 12** RJ 12
- X** Switched AC
- Y** 3-Way Switch
- C** USB-C (27W High Speed Charging Port)
- Z** USB-C (18W High Speed Charging Port)
- R** Switched AC (Rocker Switch)
- D** Dimmer Switch

Plug:

- Supplied with Low Profile Flat 45° Angle 120 VAC Plug
- Optional Standard Straight 120 VAC Plug
- Optional Straight 120 VAC Pass-through Plug

Shown in Standard Bronze (ABS) Trim Plate, featuring 2 Tamper Resistant ACs, and 2 Double USB-A Charging Ports.

- **CLEAN, COMPACT DESIGN**
- **STREAMLINED**
- **LOW PROFILE**
- **SIDE-EXITING CORDS**
- **PLUG & PLAY**
- **3.2A HIGH SPEED USB-A CHARGING FOR ALL DEVICES**
- **6' AC CORD & PLUG (FLAT PLUG STANDARD)**
- **CUSTOMIZABLE CONFIGURATIONS AND FINISHES**
- **UL LISTED FOR MOUNTING IN FURNITURE**
- **15A**



M-POWER-4T

AC POWER & DATA CONNECTIVITY SOLUTION
4T-AAUU-BZATP

Specs:

Modules/Ports:

- A** Tamper Resistant AC Receptacle
- U** Double USB-A (Fast Charging Ports - Rated for 3.2A)

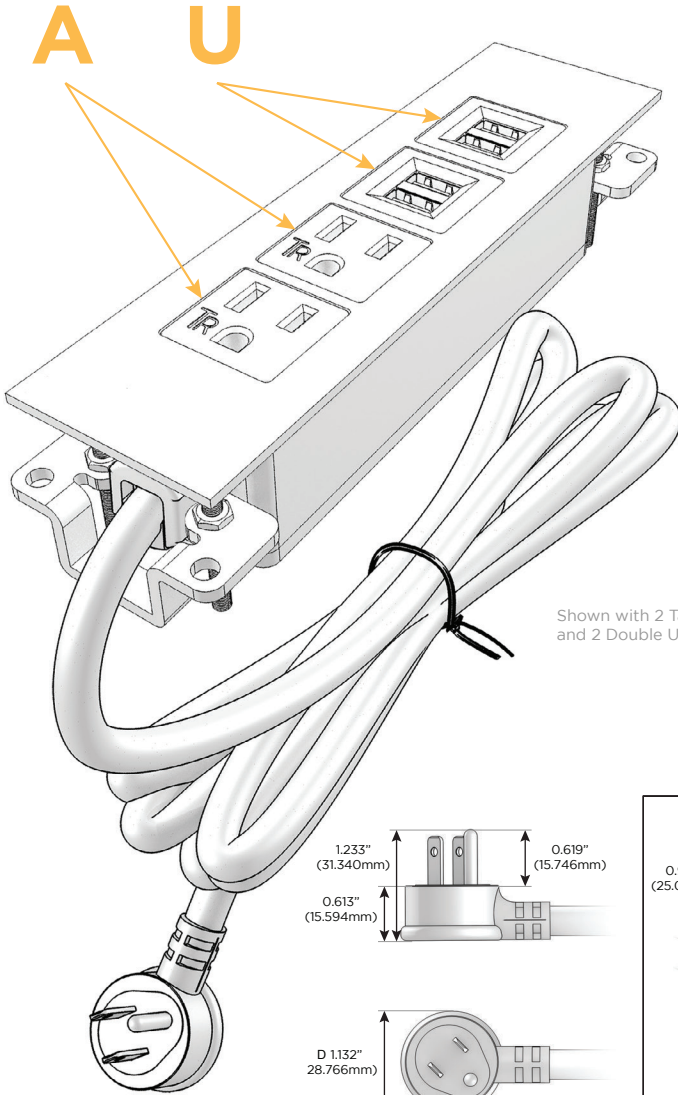

Shown with 2 Tamper Resistant ACs, and 2 Double USB-A Charging Ports.

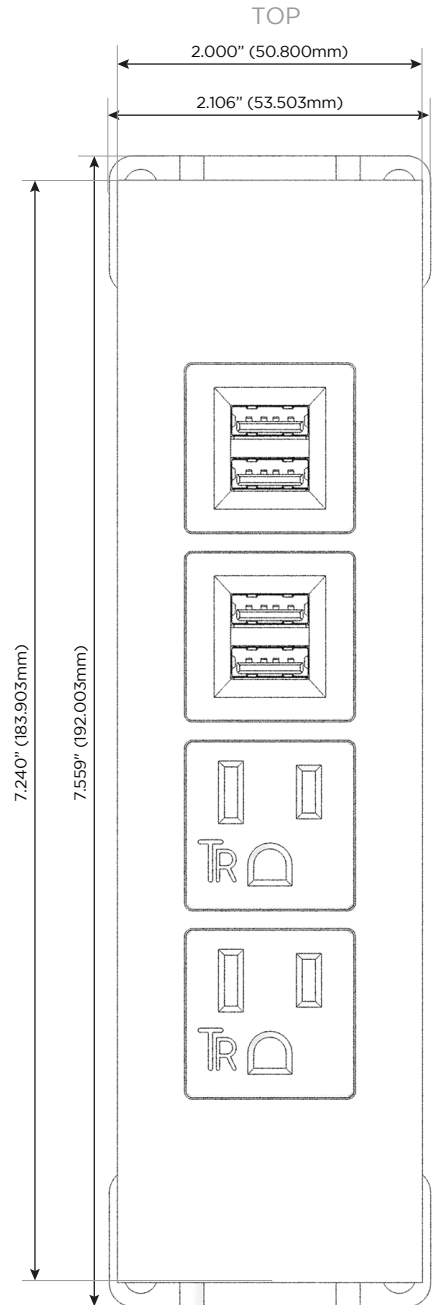
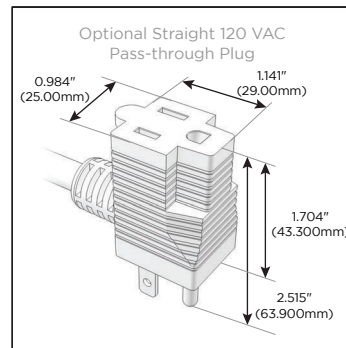
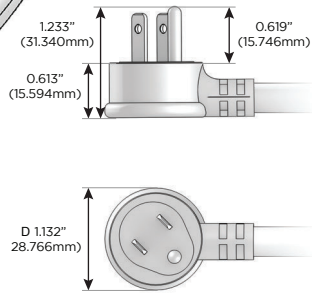

END

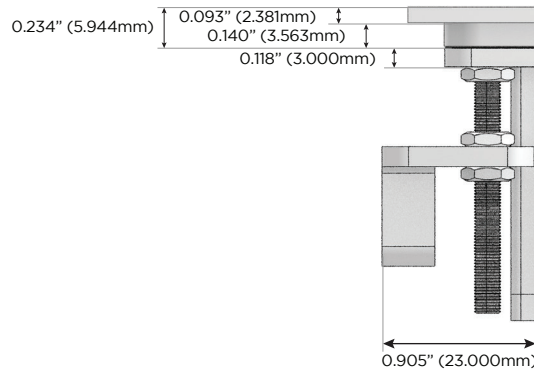
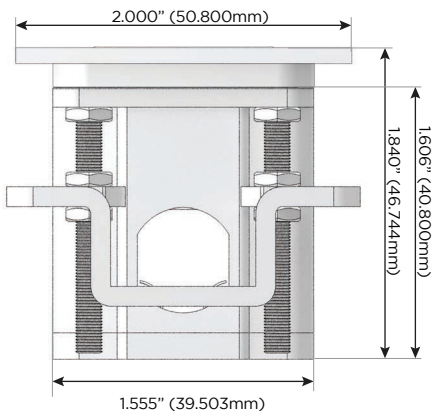

SIDE