

BCP Power Centers offer a stylish design and minimal look while meeting the demands for power and charging.

These easy to install outlets are perfect for mounting in hotel, office and all types of furniture. It is exactly what every guest wants a simple way to stay connected.

Black with 4 AC Sockets



Black with 4 AC Sockets

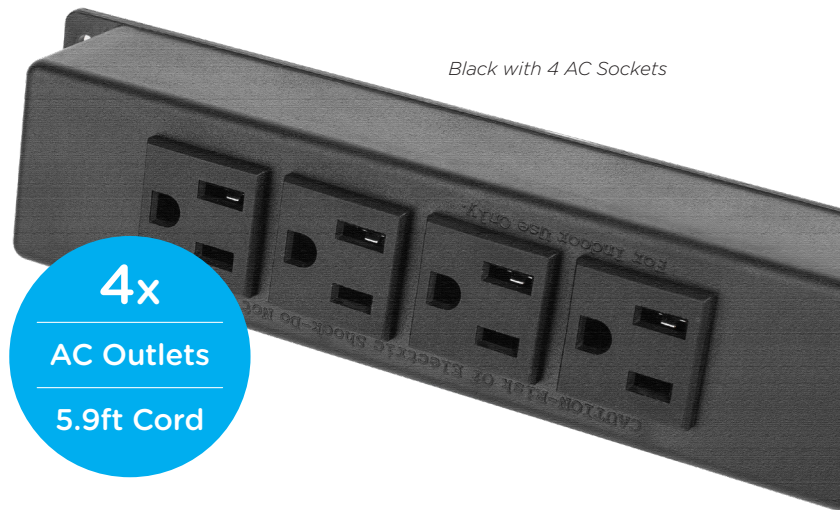

4x
AC Outlets
5.9ft Cord

Key Features

- 4 AC outlets
- Applicable voltage: 120 VAC / current: 15 A. Your electrical equipment choice
- Fire-resistant outer shell and built-in safety system provides you and your devices with complete protection
- Requires a cut out in the work surface for an easy installation

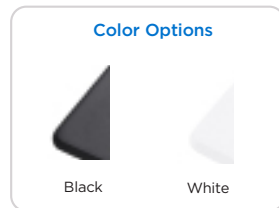

General Product Information

Product Number	BCP-4ACUL	Weight	16.73oz
Color Options	Black or White	Warranty	1 year
Dimensions	L W D		
Inches	8.27 1.79 1.38		

4 AC Power Strip

How to install

Requires a cut out in the work surface in order to sit flush.

Step 1: Mark the area according to the 4 holes cut out as shown on the diagram, ensuring you have a power outlet nearby. Make sure the surface is clean and dry.

Step 2: Drill holes of diameter 0.19 inches where marked.

Step 3: Secure power strip in place with 4 screws.

Clip the metal plate cover onto the socket.

UL certificate: Complies with UL/CUL Certification, UL 962A furniture power distribution units.

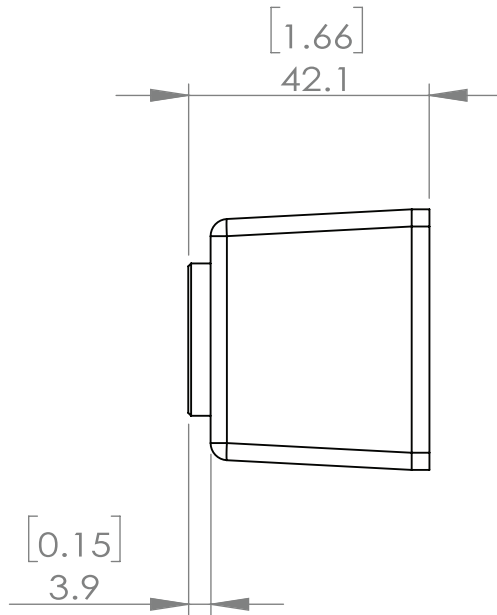
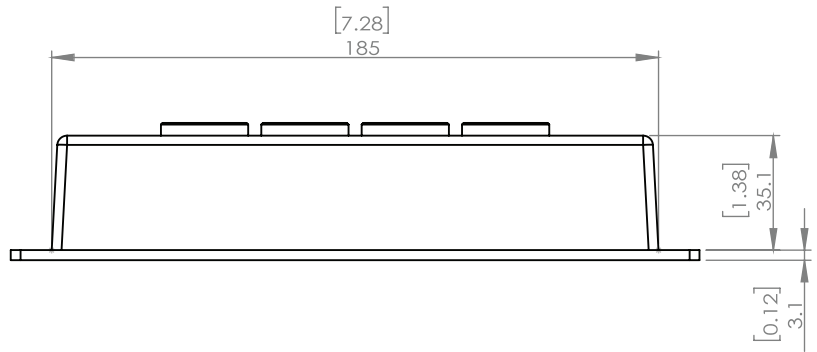
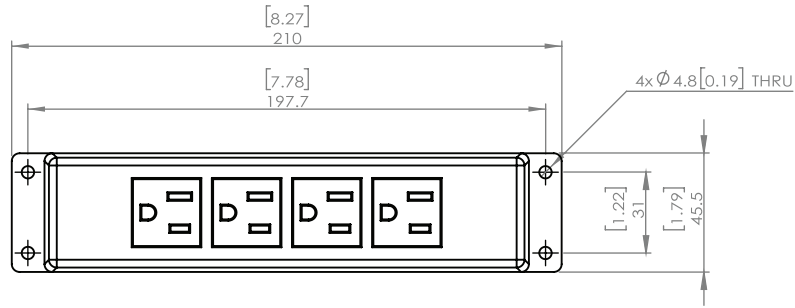

Further Product Information

Commercial: **Yes**

Indoor Use: **Yes**

Outdoor Use: **No**

Plate Included: **Yes**

Weather Resistant: **No**

Child Safety Outlet: **Yes**

Product Material: **Poly Carbonate (PC)**

